

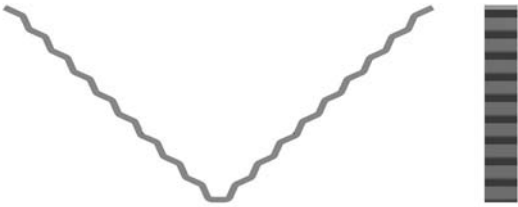

Product overview 02

 <p>FAG</p>	 <p>FAV</p>
 <p>SYA</p>	 <p>YHA</p>
 <p>YHB</p>	 <p>YHBS</p>
 <p>YRA</p>	 <p>YRB</p>



Sample of installation: Product category 2

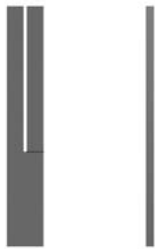
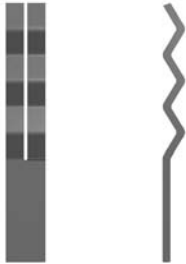
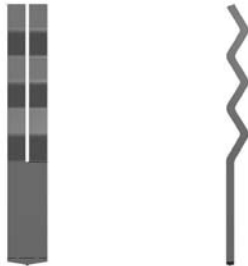
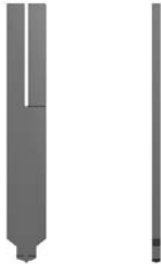
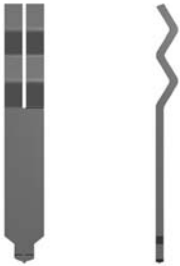
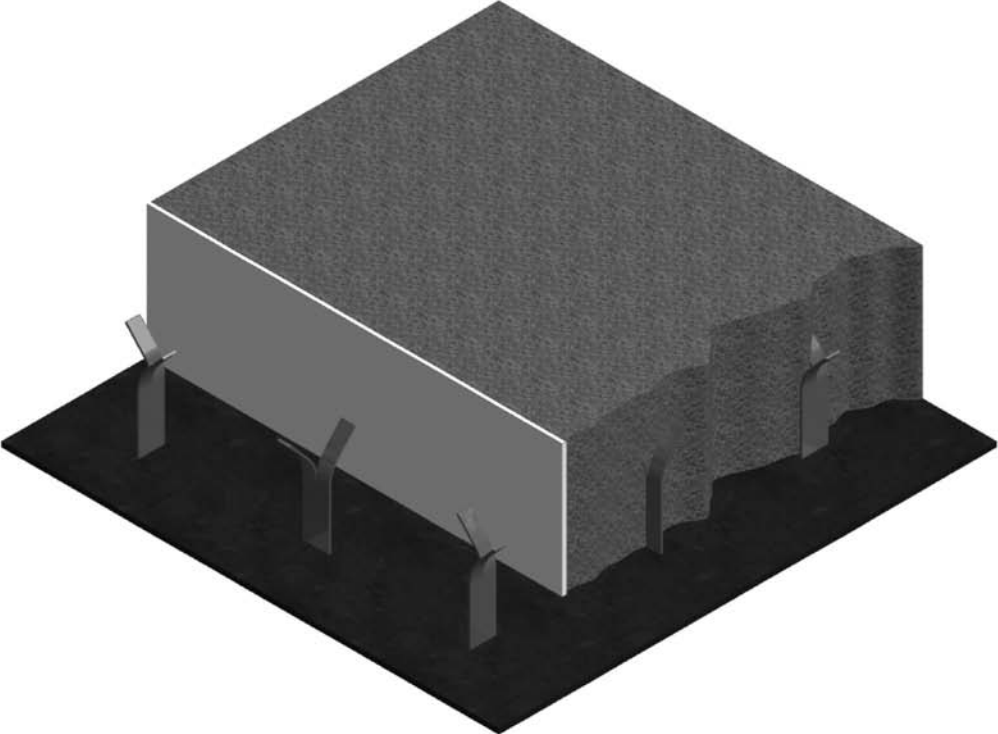
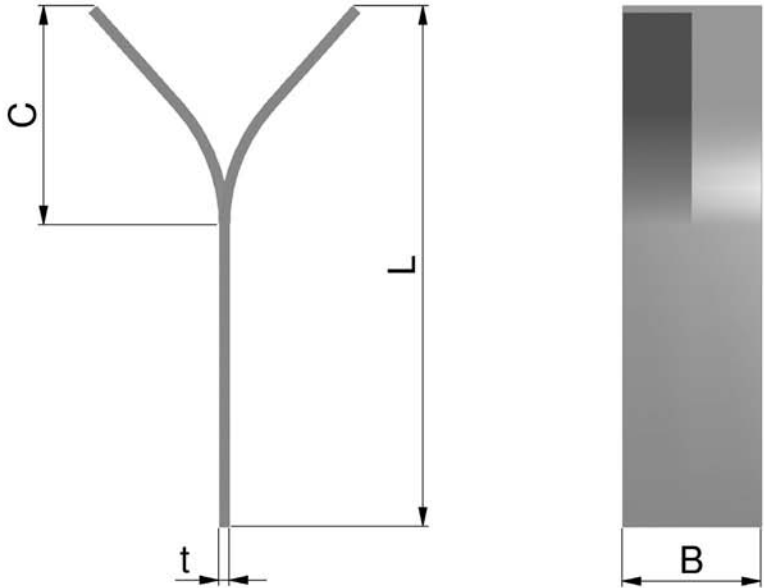

FAG-3-30-250-50-1.4841

- Anchor type
- Anchor thickness t
- Anchor width B
- Anchor length L
- Slot length C
- Alloy type

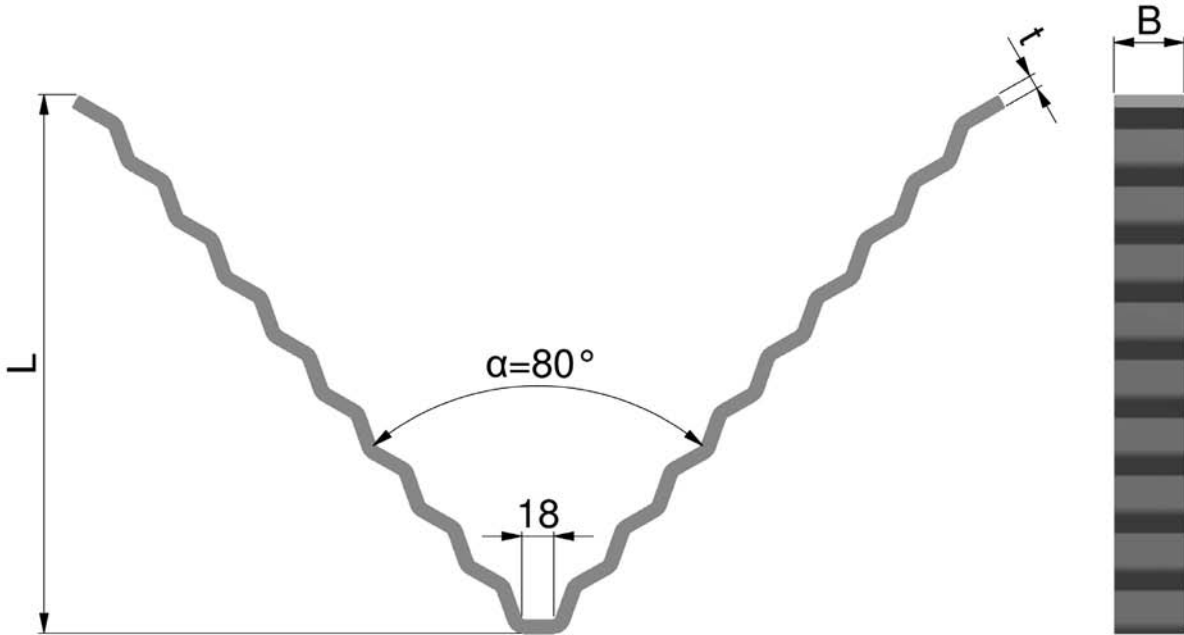

FAV-3-30-250-1.4841

- Anchor type
- Anchor thickness t
- Anchor width B
- Anchor length L
- Alloy type

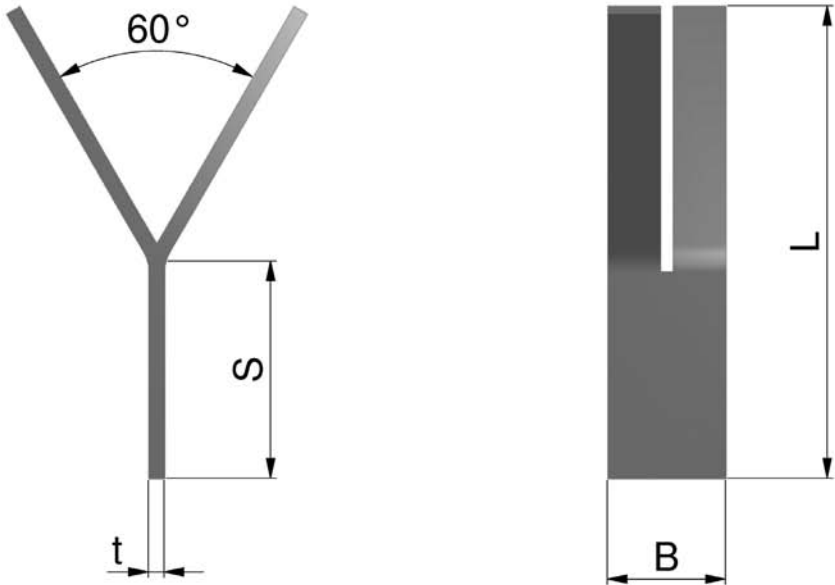

SYA-3-30-250-1.4841

- Anchor type
- Anchor thickness t
- Anchor width B
- Anchor length L
- Alloy type

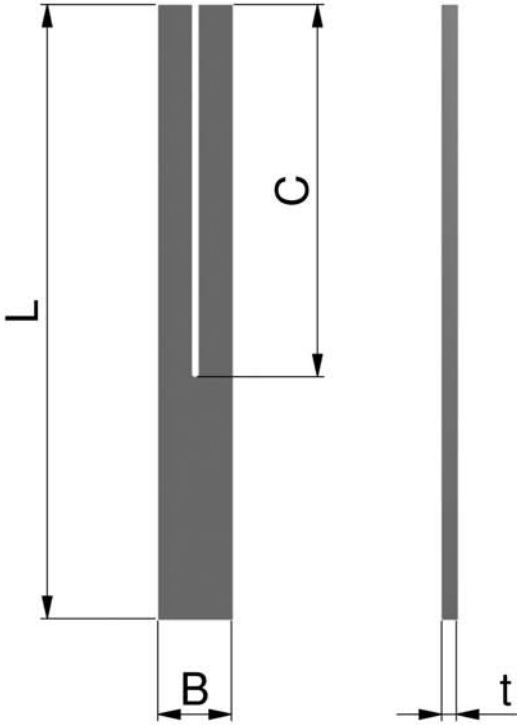

YHA-3-15-250-130-1.4841

- Anchor type
- Anchor thickness t
- Anchor width B
- Anchor length L
- Slot length C
- Alloy type

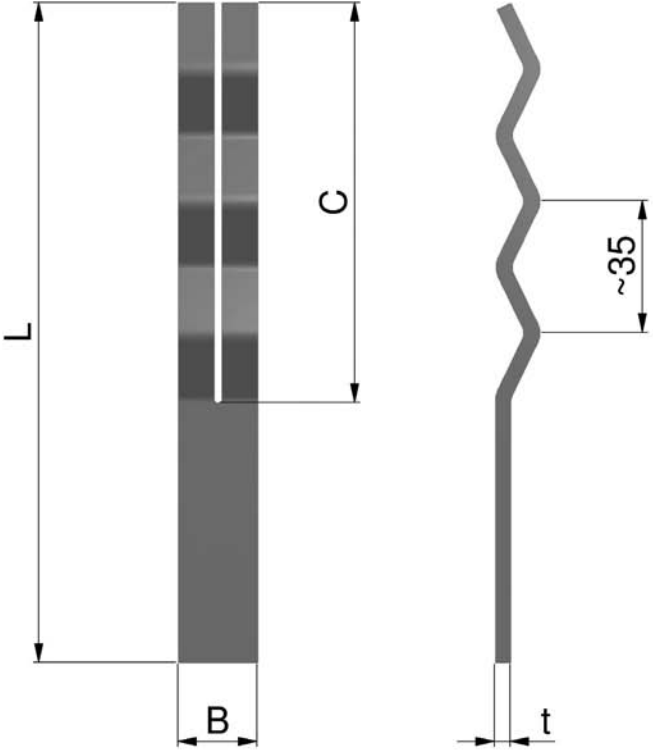

YHB-3-15-250-130-1.4841

- Anchor type
- Anchor thickness t
- Anchor width B
- Anchor length L
- Slot length C
- Alloy type

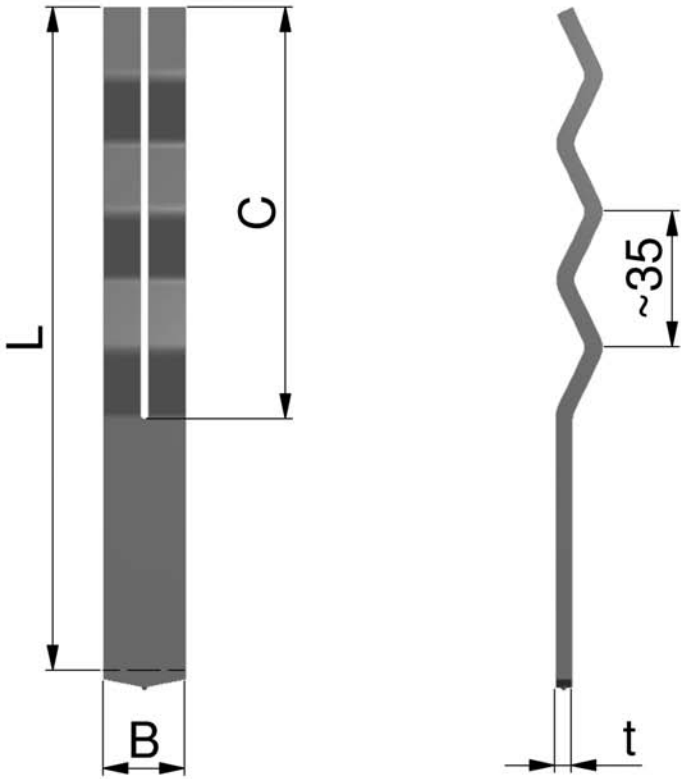

YHB-3-15-250-130-1.4841

- Anchor type
- Anchor thickness t
- Anchor width B
- Anchor length L
- Slot length C
- Alloy type

09 Ferrules

10 Stud welding unit/ Welding gun

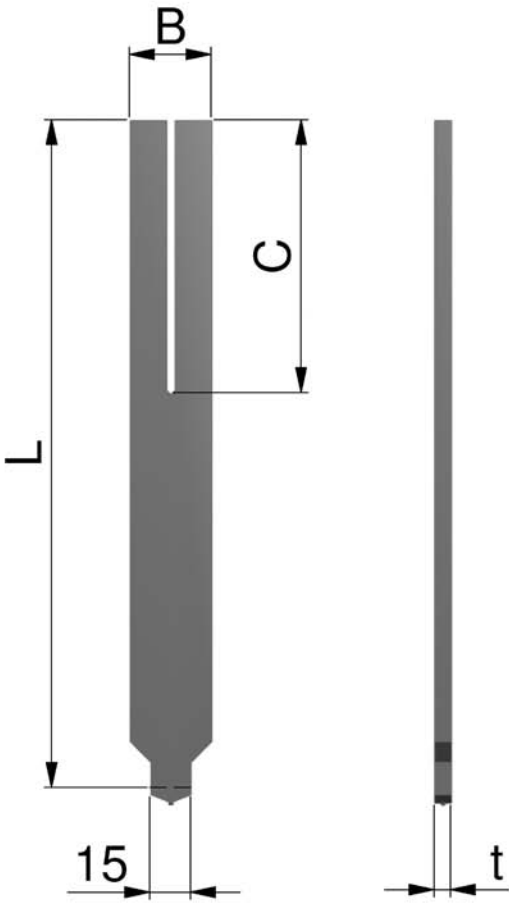

YRA-3-30-250-130-1.4841

- Anchor type
- Anchor thickness t
- Anchor width B
- Anchor length L
- Slot length C
- Alloy type

09 Ferrules ▶

10 Stud welding unit/ Welding gun ▶

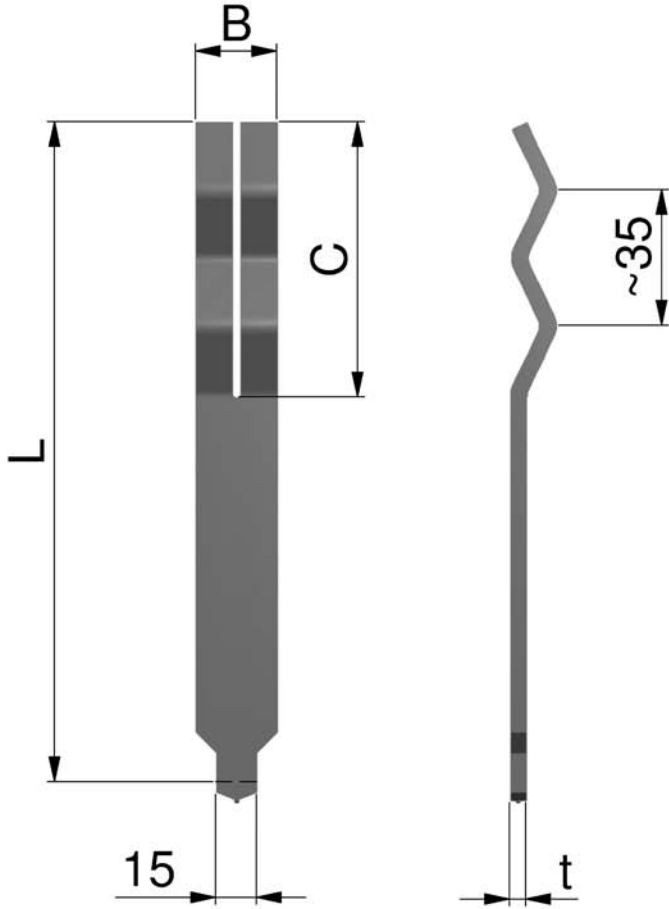

YRB-3-30-250-100-1.4841

- Anchor type
- Anchor thickness t
- Anchor width B
- Anchor length L
- Slot length C
- Alloy type

09 Ferrules ▶

10 Stud welding unit/ Welding gun ▶